

# HYDRAULIC FLUSHING RIG

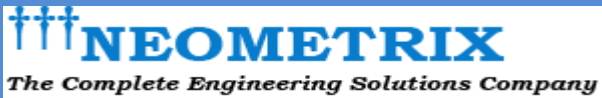

OPERATION SERVICE AND MAINTENANCE MANUAL OF

## HYDRAULIC FLUSHING RIG

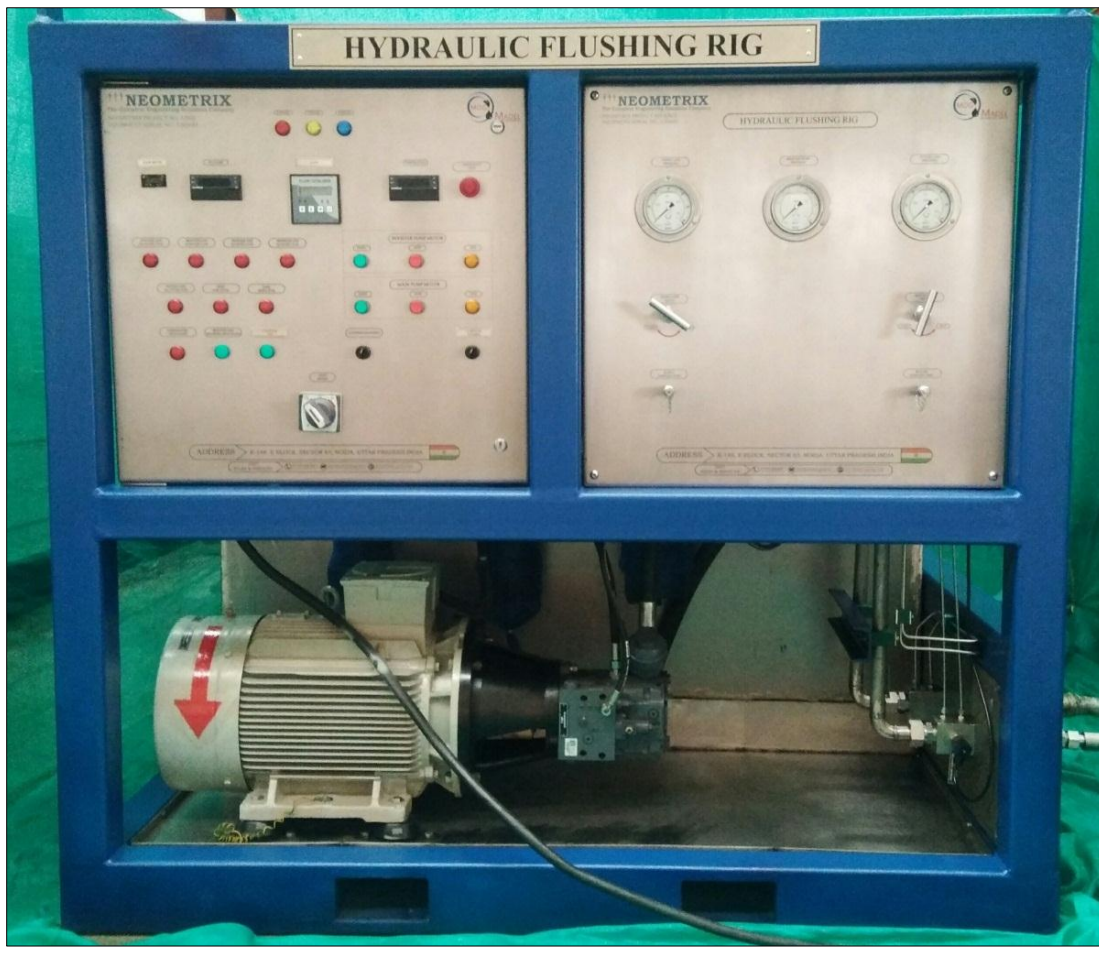

Document Prepared and Published By

**NEOMETRIX ENGINEERING (P) LIMITED.**

E-148, SECTOR-63, NOIDA, UP, INDIA - 201301

PHONE: 0120-4500 800, FAX: 0120-4500 888

contact@neometrixgroup.com, [www.neometrixgroup.com](http://www.neometrixgroup.com)

# HYDRAULIC FLUSHING RIG

## CONTENT

.NO.	Description	Page no.
1	Introduction and purpose of Hydraulic Flushing Rig	03
2	General Specifications of Hydraulic Flushing Rig	4-5
3	Description of the Hydraulic Flushing Rig	6-8
4	Major Bill of Materials	9-11
5	Description of Major Items	12-18
6	Work Panel (Details of all components on Work Panel)	19
7	Level Indication & Level Control Panel	19
8	Electrical and Electronic System	20-24
9	Standard Operating Procedure (SOP)	25-36
10	List of Do's	37-39
11	List of Do not's	40
12	Safety Features & Safety Interlocking	41-44
13	Service & Maintenance Instructions (Daily/ Weekly/Monthly/Yearly)	45
14	Trouble shooting chart	47
15	Tools & Spare Supplied	48
16	List of Drawings & Major Catalogue	48

## **1. INTRODUCTION:**

Flushing is a process which is done to clear any contaminants present in the pipe and oil after installation. The sole purpose of this process is to avoid damage caused by contaminants /dirt's to the end using equipment. The pipes are cleaned by creating a turbulent flow in the system and passing them through filters until the desired cleanliness value is obtained. The cleanliness in the pipe is measured in terms of NAS/ISO/SAE Values.

Process Flushing involves continuous recirculation of the working fluid in the system and purification at the flushing filter until the cleanliness value is obtained.

## **PURPOSE OF FLUSHING RIG:**

The objective of flushing the fluid is to eliminate contaminants particles from the fluid.

## 2. General Specifications of Hydraulic Flushing Rig

### Specification Summary

#### General

Starter Details	Star-Delta
Electrical Connections, Power Supply Starter Panel	M25 Gland Entry –Electrical
Reservoir Capacity	600 Liters
Level Switch, Set Point	Level Shutdown at 90 Liters
Air Cooler	33.7kW/415V/50Hz@1440Rpm
Operating Fluid	Water Glycol /Hydraulic oil
Operating Temperature	20°C to +60°C
Certification	Slings, Flow and pressure Test
Overall Dimensions (L x W x H)	2200mm x 1500mm x 1800m
Unit Weight	1500 kg (without oil) 2100 kg (with oil in tank)

## Flushing System

Electric Motor Power (Booster)	5.5KW/415V/50HZ@1440Rpm
Electric Motor Power (Main)	30KW/415V/50HZ@1440Rpm
Booster Pump, Max Flow Rate	0-200LPM
Booster Pump, Max Pressure	10 bar (145 psi)
Variable displacement pump flow	35lpm@350 Bar,140lpm@30 bar
Variable displacement Pump, Max Working Pressure	345 Bar (5,000 psi)
Variable displacement Pump, Displacement/Cycle	75cc/rev
Pressure Range of Variable displacement Pump	0-350 Bar
Relief Valve, Setting	350 bar (5000psi)
Outlet, Connection of supply/Return line	1”BSP (QCDC)

## Filters used in system

Booster line filter	10 micron
Booster line filter	6 micron
Booster line filter	3 micron
Pressure line filter	3 micron
Return line filter	10 micron

## 3. Description of the Hydraulic Flushing Rig

- (a) We are using Booster line pump 200 LPM with filters having range of 10, 6 and 3 microns also implementing one filter in pressure line of 3 micron and return line of 10 microns.
- (b) We are using a flow meter of range 0-140 LPM
- (c) We are using a large capacity of tank about 600 liter.
- (d) Hydraulic flushing rig is provided with two pumps of 350 bar@35 LPM and 10bar@200 LPM powered by two 3-phase induction motors of 30kW and 5.5kW respectively.
- (e) The hydraulic flushing rig is installed with an Electrical panel for motors with indicating light for on/off. An Emergency switch is provided on the panel for instant shut off the whole system. A three phase wire has to be connected to the MCB provided on the control panel.
- (f) The hydraulic flushing rig is installed with a mechanical panel where we can see the pressure of supply line, return line and booster line. Needle valve is also on panel for controlling of pressure and flow.
- (g) Skid is made of Square Pipe and all welded steel strengthened by cross members. Lifting hook is provided for lifting machine. Forklift space is also in front base of skid for easy lifting.

# HYDRAULIC FLUSHING RIG

(h) In hydraulic flushing rig provided with cooling system by air cooler having Cooling Performance at Flow of 140 LPM: 21.5 kW at EDT of 20°C.

(i) **Work Panel**

The work panel consists of following constituents panels:

**1. Electrical panel**



The electrical panel consists of DRO's of pressure transmitter, flow meters, Hour timer, and temperature transmitter. All the DRO's are used for deliver 4-20 mA electrical signal for smooth operation.

All the DRO's are grounded and placed at the upper portion of the panel to monitor and diagnose the performance of the test being done on the panel.

## Electrical panel consist:

- (a) Pressure indicator
- (b) Temperature indicator
- (c) Flow indicator
- (d) Hour meter
- (e) Clogging indicator (filters)
- (f) Tank level indicator
- (g) Cooler on/off switch
- (h) Emergency stop
- (i) Main on/off
- (j) Temperature switch
- (k) Loading/Unloading
- (l) Pressure switch indicator
- (m) Booster pump start/stop
- (n) Main pump start/stop

## (ii) Mechanical panel consist:

- (a) Booster line pressure gauge
- (b) Supply line pressure gauge
- (c) Return line pressure gauge
- (d) Supply line Needle valve
- (e) Return line Needle valve
- (f) Sampling port



# HYDRAULIC FLUSHING RIG

## 1-Major Bill of Material

T-PED-A2026-BOM-REV-01 (FINAL)					
Major Bill Of Material (Mechanical)					
S.No.	Circuit Code.	Nx Part No.	Item Name	Item Specifications	Qty. for one Unit
1	1	2A2026P0001	Hydraulic Oil Tank	Material : SS-304, 600 Liters Oil Capacity. Dimension - 1800 ( L ) X 550 ( W ) X 600 ( H )	1
2	2	2A2026P0002	Drain Valve	1/2" Ball Valve- SS-316 , Working Temperature 70 degree C ,Working Fluid: glycol and water/hydraulic oil	1
3	3	2A2026P0003	Level Gauge	Length =254mm , Working Media : Water /Glycol/ hydraulic oil, Maximum temp:70 deg C	1
4	4	2A2026P0004	Filler Breather	40 micron Filtration Filler Breather , Temperature 70 degree C , Working Media : Water /Glycol/ hydraulic oil	1
5	5	2A2026P0005	Temperature Gauge	Tank Mounted Temperature Gauge , Steam Length 600 mm , DIAL Size- 100mm , Range 0-100 degree C , connection :1/2 " BSP Working Media : Water /Glycol/ hydraulic oil	1
6	6	2A2026P0035	Temperature transmitter	Transmitter: T15, transmitter, 4#20 mA, universal programmable, factory preset from 0 to 150 Deg C	1
7	7	2A2026P0057	1" HOSE PIPE	Working pressure: 350 bar , medium: water + glycol, end connection : 1" BSP, Length : 1300mm	1
8	8	2A2026P0008	Level Switch	Steam Length 600 mm , Low Level 100mm Measured from below , High Level 500 mm Measured from below , Max Temperature 70deg C degree C , Working Fluid: Water Glycol/ low viscosity hydraulic oil	1
9	9	2A2026P0009	Suction strainer	Flow - 150 LPM , Thread 2" BSP Female, Micron rating:90 micron Working Fluid: Glycol+water/hydraulic oil	1
10	10	2A2026P0010	Cooling/booster Line Fixed Displacement Pump Pc	Max working pressure 10 Bar, flow : 140 LPM @ 1450 RPM,97CC Working Fluid: Glycol+water/hydraulic oil	1

# HYDRAULIC FLUSHING RIG

11	11	2A2026P0011	Electric Motor Mc	Foot Cum Flange Mounting ,Three Phase Motor, Continuous Duty , Supply 415V AC , 50 HZ. Flange mounted ,5.5 kW, 1500 RPM , Protection class IP55 or Better, IE3 Class MOTOR	1
12	12	2A2026P0012	Bell housing & Coupling	For motor and pump 1 & 2	2
13	13	2A2026P0013	Booster line Filter A	10 micron absolute filtration, Design Pressure 10 Bar 150 LPM Flow Capacity, With Bypass, With Visual and Electrical Clogging Indicators, Working Media - glycol and water/hydraulic oil. Maximum temp:70 deg C	1
14	14	2A2026P0014	Booster line Filter A	6 micron absolute filtration, Design Pressure 10 Bar,150 LPM Flow Capacity, With Bypass, With Visual and Electrical Clogging Indicators Working Media - glycol and water/hydraulic oil. Maximum temp:70 deg C,	1
15	15	2A2026P0015	Booster line Filter A	3 micron absolute filtration, Design Pressure 10 Bar, 150LPM Flow Capacity, Without Bypass, With Visual and Electrical Clogging Indicators Working Media - glycol and water/hydraulic oil. Maximum temp:70 deg C,	1
16	16	2A2026P0055	AIR COOLER	Air Cooled Oil Cooler with 2 HP Motor Model: AH-1890T, with 2 HP Motor Oil Flow Range: 140 LPM Oil: Water (35%) + Glycol (65%)	1
17	17	2A2026P0056	1-1/2" HOSE PIPE	Working pressure: 10 bar , Medium: water + glycol, end connection : 1" BSP	1
18	18	2A2026P0018	Varivale displacement pump with power controller	Max. displacement : 71 cc/rev , Nominal pressure - 350 bar ,with LR Controller ( 35lpm at 350 bar and 110 lpm at minimum pressure) Working Fluid: glycol+water/hydraulic oil	1
19	19	2A2026P0019	Electric Motor MP	Foot Cum Flange Mounting ,Three Phase Motor, Continuous Duty , Supply 415V AC , 50 HZ. Mounting B3B5 and B3 , 30 kW, 1500 RPM , Protection class IP55 or Better, IE3 Class MOTOR	1
20	20	2A2026P0020	pressure relief cum unloading valve	pressure relief cum unloading normally open valve , Pressure relief 0- 350 bar rating, Flow 150 LPM ,subplate mounting.Working Fluid: Glycol+water/hydraulic oil	1
21	21	2A2026P0021	Pressure LINE FILTER 3 MICRON	150 LPM, 359 BAR 3 micron with visual and clogging indicator with by clogging indicator,maximum temp: 70 DEGREE C, Working fluid : water+ Glycol/ Hydrualic oil	1
22	22	2A2026P0022	Flow Meter	Flow Range: 13-130 LPM , Turbine Type , Max Working Pressure 350 bar, maximum temp:70 deg C	1

# HYDRAULIC FLUSHING RIG

23	23	2A2026P0023	Needle valve	110 lpm,350 bar ,Working media: water glycol/ hydraulic oil.	2
24	24	2A2026P0024	Pressure Transmitter	0-400 bar,temp:0-100deg C,Process conn-1/2" bsp	2
25	25	2A2026P0025	Pressure Gauge	0 – 400 BAR,Dial size:100mm Conn. : 1/2" BSP (M) Back with 3hole front flange	2
26	26	2A2026P0026	Minimess hose and coupling	1.25" , 400 bar	1
27	27	2A2026P0027	Check Valve	Line Mounted , Cracking Pressure 0.5 Bar , Flow 150 LPM;Working Fluid: Glycol+water/hydraulic oil	1
28	28	2A2026P0034	Pressure Switch	0.4-4 Bar SS 316 Bellows with SS 316 Connector	1
29	29	2A2026P0029	Return line filter 10 microne	150lpm,10 micron return line filter with visual and electrical clogging indicator with bypass check valve, Maximum temp:70 deg C,Working Fluid: Glycol+water/hydraulic oil	1
30	30	2A2026P0033	pressure guage	Range : 0 – 10Kg/cm2,Nominal dial size : 160 mm; Measuring &,Movement : Stainless Steel; Case : SS with case vent; Window : Safety glass; Dial : White aluminium;Pointer : Black aluminium; Accuracy : 1% of FS; Conn. : 1/2" BSP(M) Back with 3 hole front flange;,Glycerine filling : Yes	1
31	31	2A2026P0090	QCDC	SIZE:1" ,WP:350 BAR,FLOW:140LPM	2
31	NA	2A2026P0030	Electrical Panel	Ss	1
33	NA	2A2026P0032	MECHANICAL PANEL	SS	1
34	NA	2A2026P0033	1 HOSE PIPE	Working pressure: 350 bar , medium: water + glycol, end connection : 1" BSPF, Length : 5000mm	2

# HYDRAULIC FLUSHING RIG

## (5) Description of major items

- **Hydraulic tank**

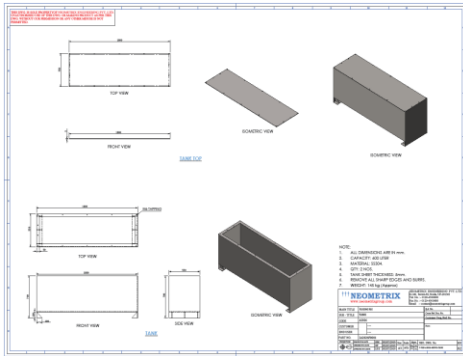

Stainless steel 304 Hydraulic reservoir having useful capacity of 600 liters is provided to store hydraulic oil/water glycol. The reservoir is constructed with welded rectangular shell Drain valves, oil level indicator.

- **Details of High Pressure Pump:**

- i) Independent for each delivery line.
- ii) Variable displacement axial piston pump with pressure control.
- iii) Rating:

Max Design pressure:	420 bar
Continuous working pressure:	350 bar
Displacement:	71 cc per rev.
Max. Continuous flow:	140@30 bar

- **Details of Fixed displacement Flow pump:**

Maximum working pressure:	10 bar
Flow:	200 LPM

- **Details of Air cooler:**

The water/glycol will heat up as it flows through the system. For maintaining the temperature of the hydraulic oil/water glycol below 60 degree centigrade an air cooled air cooler is provided of following specifications:



Type:	Air cooler (fins)
Design pressure:	10 bar
Design temperature:	80 degree C
Test pressure:	13 bar
Flow:	140LPM
Specific Cooling at Flow of 140 LPM:	1.075 kW/°C.
Cooling Performance: at Flow of 140 LPM:	21.5 kW at EDT of 20°C.

# HYDRAULIC FLUSHING RIG

- **Details of Control valves:**

**1) Pressure relief cum unloading valve:** Setting pressure: 350 Bar

A relief valve or pressure relief valve is a type of safety valve used to control or limit the pressure in a system; pressure might otherwise build up and create a process upset, instrument or equipment failure, or fire. The pressure is relieved by allowing the pressurized fluid to flow from an auxiliary passage out of the system.



Component series  
Maximum operating  
Maximum flow

5X  
pressure 350 bars  
650 l/min



## 2) Pressure control valve:

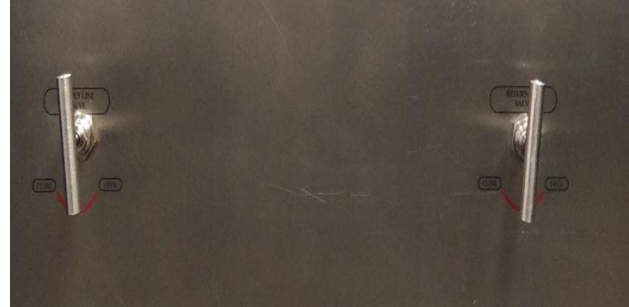

A needle valve is a type of valve with a small port and a threaded, needle-shaped plunger. It allows precise regulation of flow, although it is generally only capable of relatively low flow rates.

**Working pressure: 350 Bar, size: 1"**

## 3) Check valves on manifolds: Cracking pressure at 0.5 bar

A check valve or non-return valve is a valve that normally allows fluid to flow through it in only one direction.



# HYDRAULIC FLUSHING RIG

## 4) Sampling valve

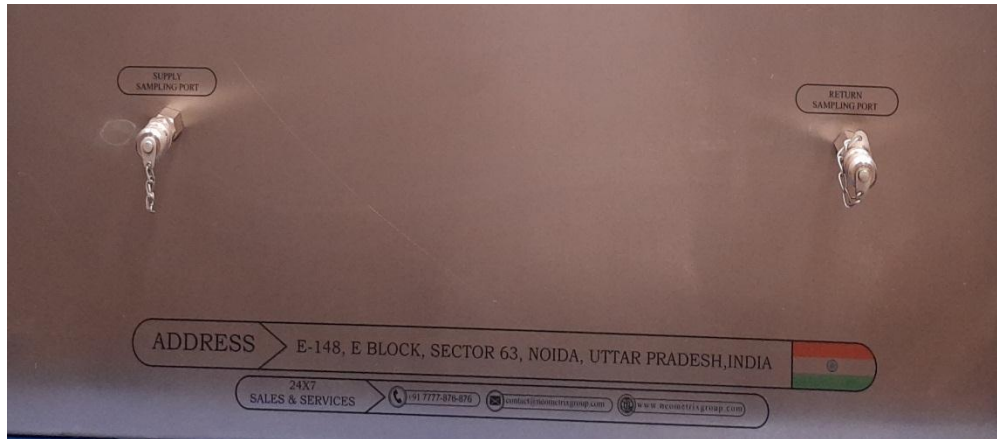

## 5) Tank drain valve

Size: 1/2"

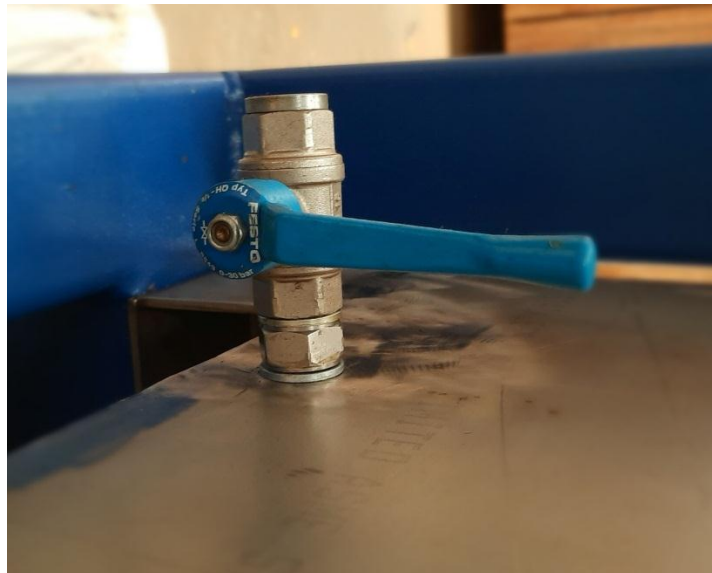



# HYDRAULIC FLUSHING RIG

## 6) Quick release couplings:

Quick Connect-Disconnect Couplings (QDCs) provide a means of rapidly disconnecting and connecting a fluid line without loss of hydraulic fluid in a system.

**Working pressure: 350 bar**

**Material: carbon steel**

**Connection: 1" BSPF**



- **Details of filters:**

S.no.	Description	Filtration rating	By pass check valve	Clog indicator
1	Booster line filter	10 micron	yes	yes
2	Booster line filter	6 micron	yes	yes
3	Booster line filter	3 micron	yes	yes
4	Pressure line filter	3 micron	yes	yes
5	Return line filter	10 micron	yes	yes

# HYDRAULIC FLUSHING RIG



**Pressure line filter**



**Booster line filter**

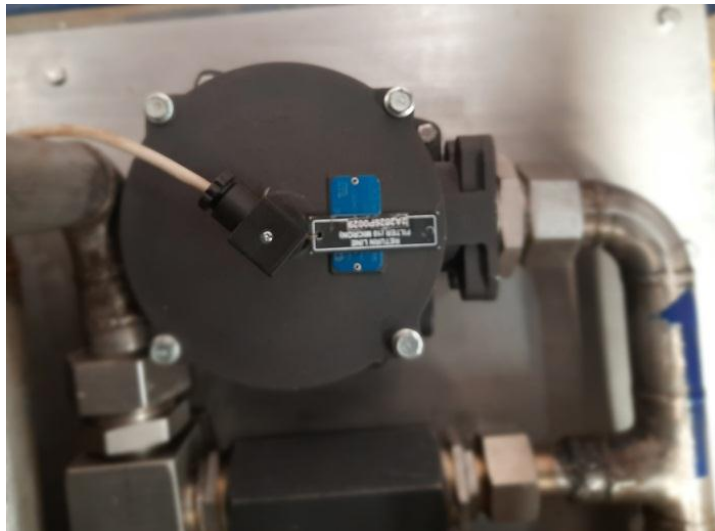

**Return line filter**

# HYDRAULIC FLUSHING RIG

## 6. Work Panel (Details of all components on Work Panel)

All instruments are placed in the front side of the work panel for ease of visualization. It contains group of DRO's / indicators. It contains group of Needle vales/ pressure relief valves/ switches. Control panel is made out of SS-304 plate. There are labels under each items of the panel for identification.

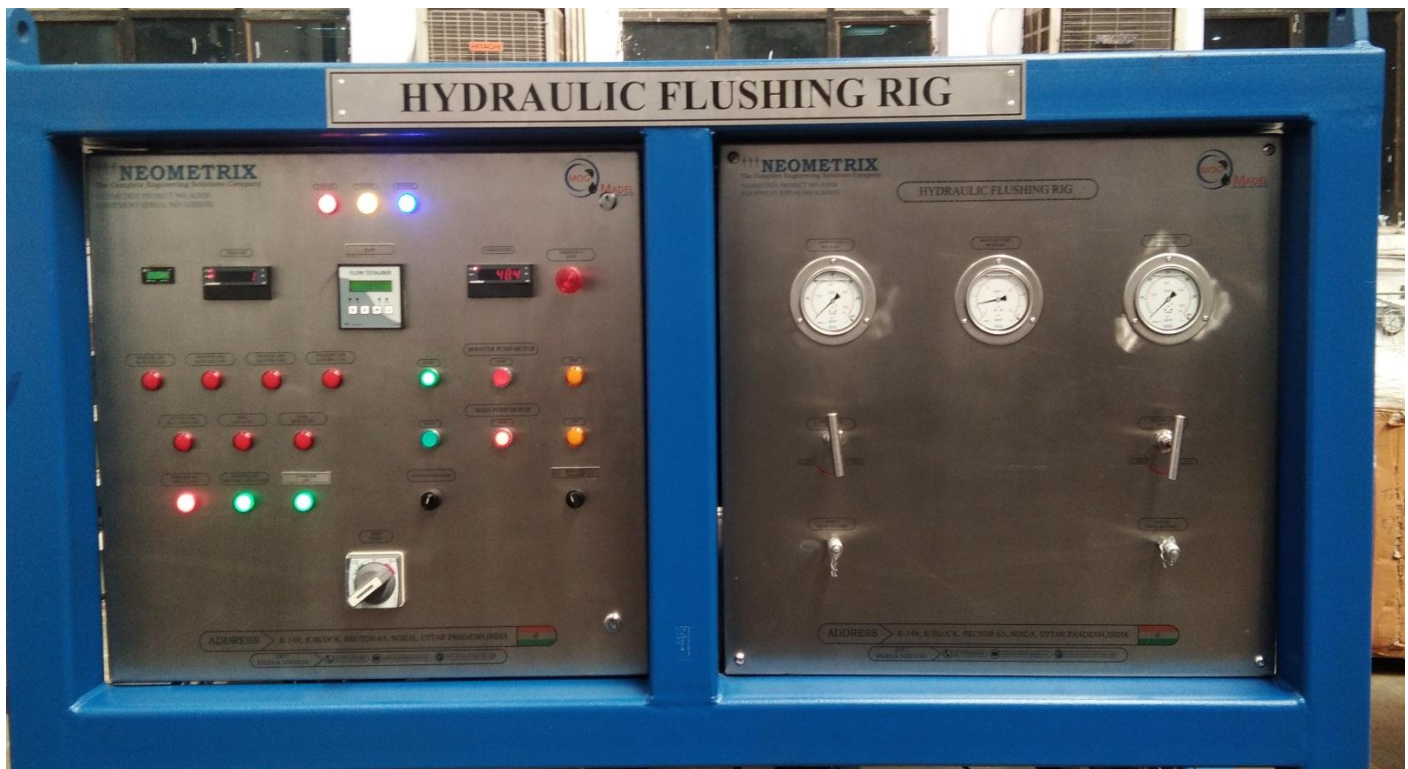

## (7)Level Indication

For Oil level controls, following Items are given.

1. One Oil level switch for Interlocking for Tank oil low level
2. LED for low level/high level.
3. Visual Oil Level we can monitor on tank.

# HYDRAULIC FLUSHING RIG

## (8) Electrical and Electronic System



### Electrical System

There is an electrical panel enclosure consists of MCB's, relays terminals etc. is placed at hydraulic flushing rig . There is also 0-24V, 5 Amp DC supply from the work panel.

**An electrical system is provided to control following operation / logic:**

- a) **Booster motor start & stop:** It is used to run the booster fixed displacement pump so that pump sucks the hydraulic oil from tank and pass through the bank of 10, 6, 3 micron filters and then through air cooler for cleanness and cooling the oil before pass through the main pump.
- b) **Emergency Stop:** It is used to stop the whole system.
- c) **Cooler on/off:** It is used to cool the oil when system is running.

- d) Booster line pressure switch: It is used to cut the electrical contact when pressure is going beyond the setting pressure.
- e) Main motor start and stop: It is used to run the variable displacement pump which gives different pressure and flow for flushing.
- f) Main on/ off: It is used to start the system.
- g) Filters clogging indicator: It is used to indicating that when filter element is replaced i.e. when red indicator is on so we need to replace the filter element by other new filter element.
- h) Tank low/high level indicator: It will showing that oil level in the tank is low or high i.e. we cannot run the system.
- i) Flow totalizer display: It will be showing flow rate in lit/min.
- j) Pressure display: It will be showing pressure in bar of supply pressure line and return pressure line.
- k) Hour meter display: It will be showing how much hour's booster pump motor has run.
- l) Temperature display: It will be showing temperature of oil in degree centigrade.



# HYDRAULIC FLUSHING RIG

- **Electronic system**

## 1. DRO



LED height of display of 14.22mm, 20mm, 96mm digital read out are provided on the indicating panel which shows the readings as per the electrical signal it received from the transducers (pressure Transducer, RTD). For further specifications of DRO's, please refer the catalogue of industrial control and drives.

## 2. Timer



Timing of endurance cycle is provided with Multi –function dual display Timer of selec manufacturer. The switch may be connected to an electric circuit operating from mains power, including via a relay or contactor or low voltage.

## 3. Flow meter indicator

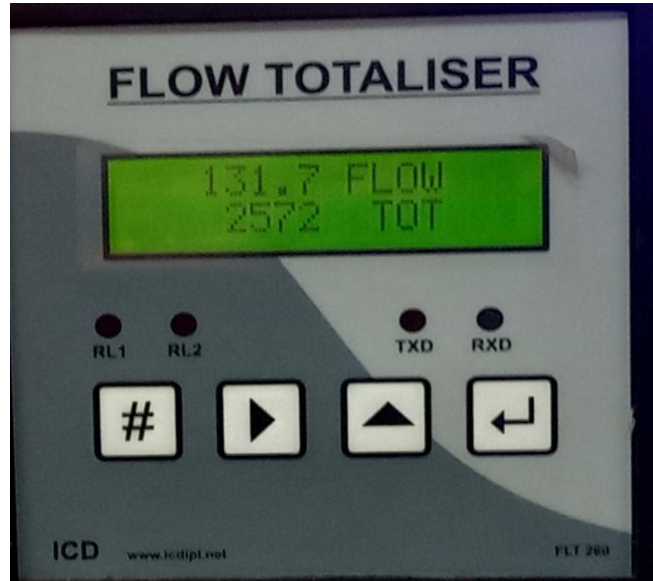

- Micro controller based design
- LCD display
- Ma/Volts/Pulse inputs
- Range programmable to full scale reading
- Monitoring and control applications
- Optional current output
- Optional RS-485 port
- Display size:2 row 16 character LCD
- Range setting in Engg units: .01 to 9999 for rate,9999999 for totalizer
- Resolution: 0.01/0.1/1 for instant flow , 1 for totalizer
- Accuracy : +0.05%OFS
- Input: 4-20mA,1-5V,0-10v,0-0kHz
- Flow: lit/min

# HYDRAULIC FLUSHING RIG

## 4: Hour meter indicator



Display Type	LED
Display Configuration	7 Digits
Input	Mains , Potential Free Contact , PNP Sensor
Range	19999.99hrs, 199:59:59 hr:min:sec
Reset	Remote, Enable /disable mode
Accuracy	Setting: ± 5% Of Full Scale
Measure	Hour/min/sec
Supply Voltage	90 to 270V AC / DC
Size	48x 22mm
Mounting Type	Panel Mount



# HYDRAULIC FLUSHING RIG

## (9) Operating Principle of Hydraulic Flushing Rig :-

### TESTING GUIDELINES:-

➤ Before starting the motor with their corresponding pump, following condition should be checked or met

a) Both supply and return valve of system should be opened.



b) Hydraulic oil/water Glycol should be checked and it should be up to appropriate level about 450 liters and you can also check on panel by level switch



# HYDRAULIC FLUSHING RIG

c) Relief valve of particular system should be **closed** during loading condition.

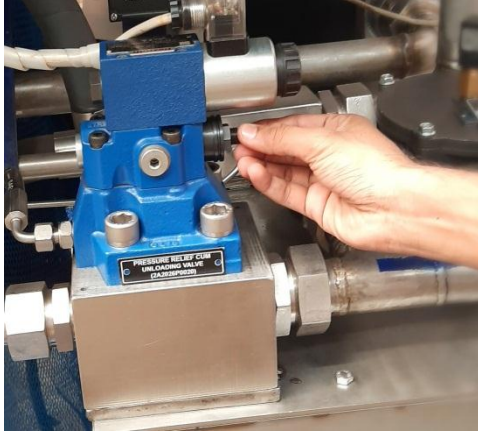

d) **Rotation of the motor** should be in accordance to the pump.



# HYDRAULIC FLUSHING RIG

e) Hydraulic Oil /water glycol to be filled should be **CLEAN**.



f) QCDC should be **Connect properly**.

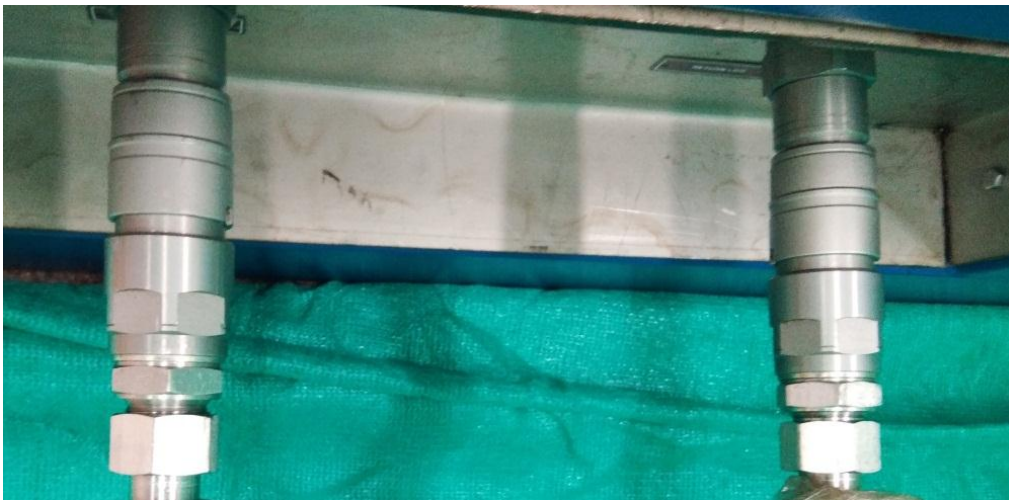

# HYDRAULIC FLUSHING RIG

g) Use the test schedule guidelines before testing.

h) Check the main power connection

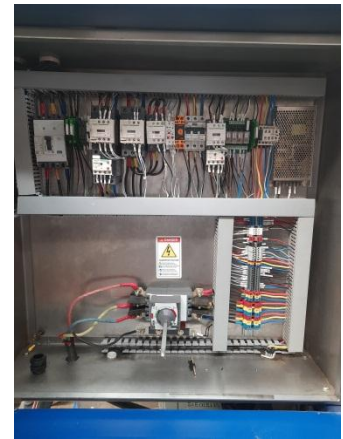
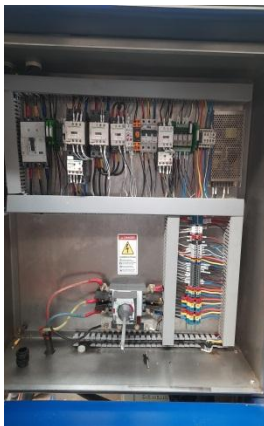



# HYDRAULIC FLUSHING RIG

- i) Reset the system before start Booster motor by press Emergency stop



## • HOW TO RUN MACHINE

- Connect QCDC from supply Ports and Return port.

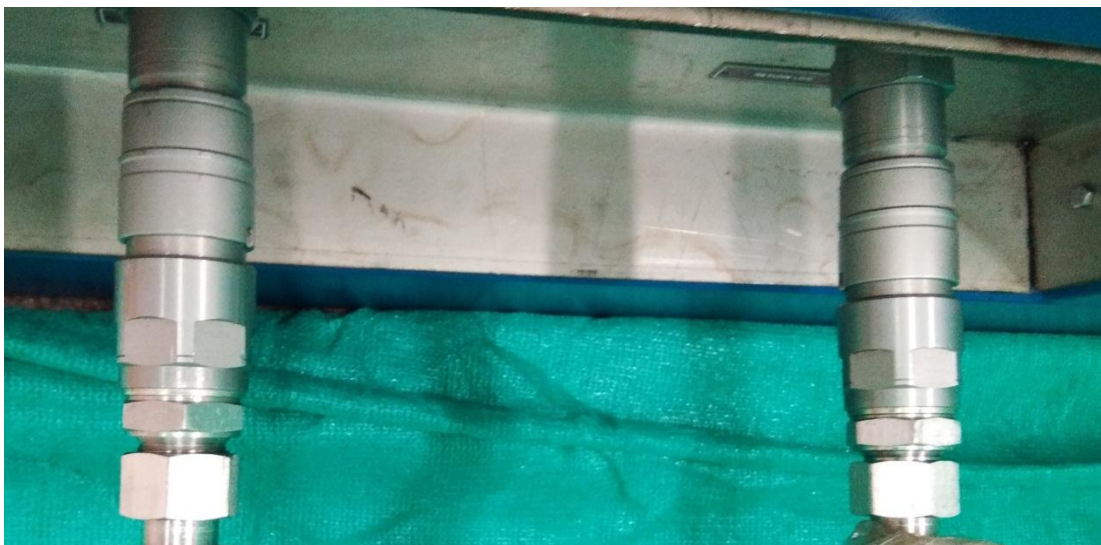

# HYDRAULIC FLUSHING RIG

- Always keep unloading condition before start main motor.



- Keep Needle Valve to be open



# HYDRAULIC FLUSHING RIG

- After Checking all the measures **Start** the Booster motor one and check pressure of booster pump on user panel.



- After start cooler



# HYDRAULIC FLUSHING RIG

- Keep watch **pressure switch indicator** should be ON.
- Pressure switch set on 1.5 bar



- Look **Booster pump** pressure on panel. It should goes up approx 1.5 bar





# HYDRAULIC FLUSHING RIG

- After start main motor and check flow and pressure



- **CLOSE** the Pressure cum unloading relief valve and Set the dump Pressure as per your requirement.

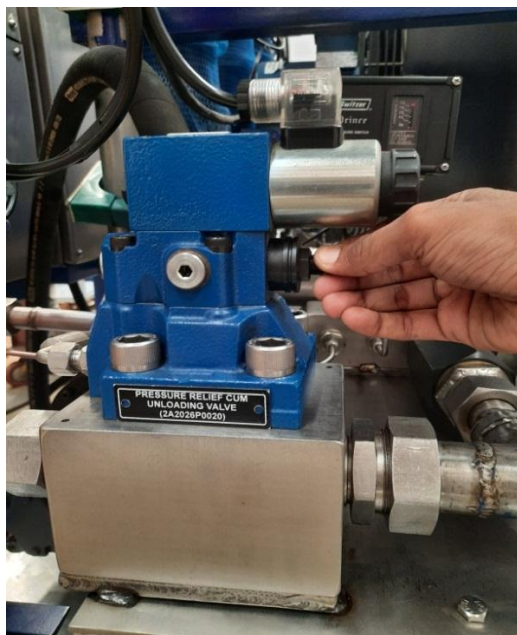

# HYDRAULIC FLUSHING RIG

- **CLOSE** the return line Needle Valve Slowly to get desire flow and pressure.

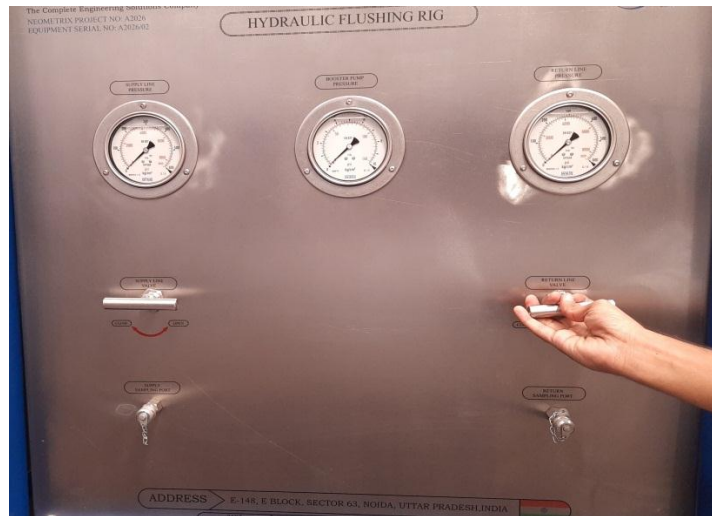

- Connect QCDC properly and flush as per desired.

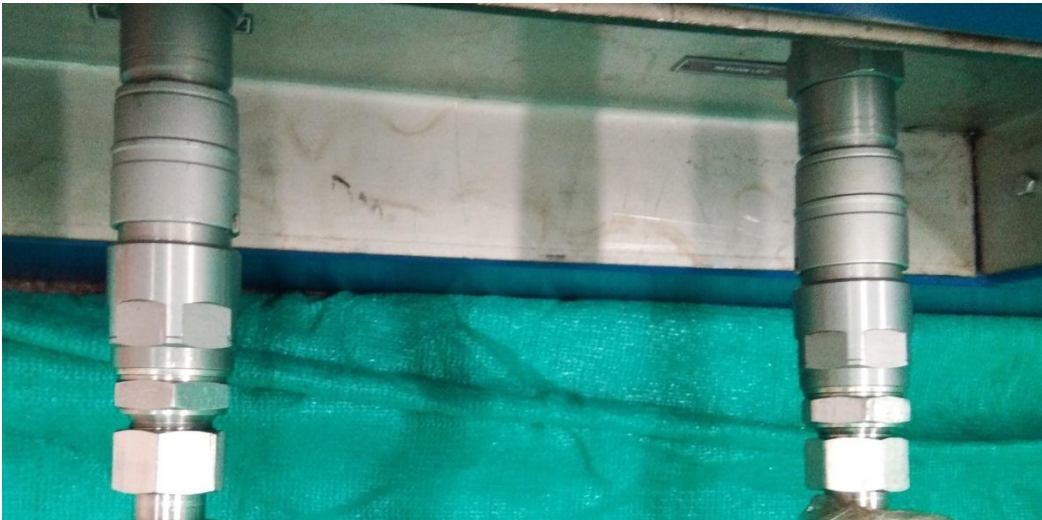

# HYDRAULIC FLUSHING RIG

- After flushing complete **open needle valve** and drop pressure.

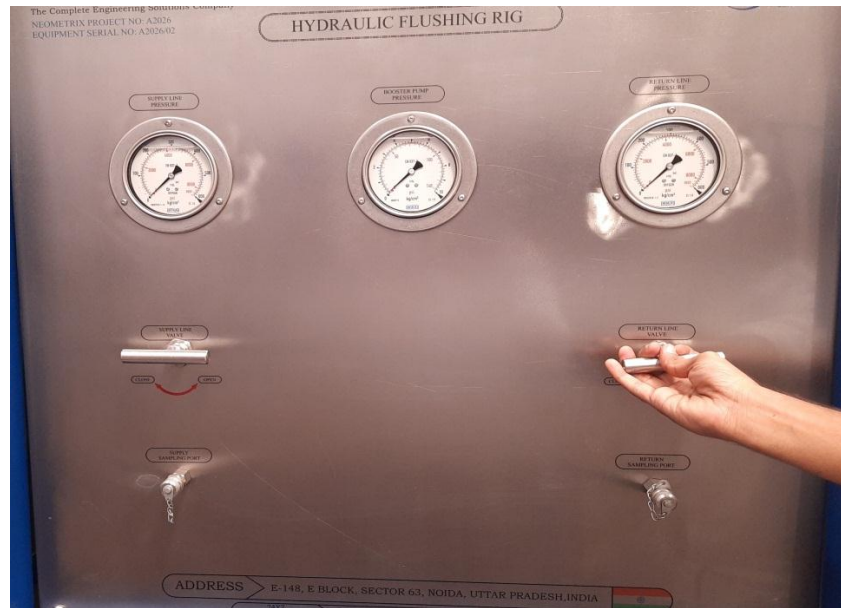

- Keep **unloading condition** before stop main motor.







## 10: Do's

1. Observed the complete hydraulic circuit and after getting rough Idea, read the manual carefully.
2. Do check the level of the HYDRAULIC OIL/water glycol filled in the Tank; it should be up to the high level mark of the level indicator in order to avoid increase in the temperature of oil. It also helps in better suction for the Pump.
3. System must be clean at all times. Many failures to hydraulic Equipment are caused by dust or foreign matter introduced in to the system through lack of care during operation or maintenance. Check the cleanliness of the fluid.
4. Do check that the pressure line valve is open otherwise the Pump may get Damaged.
5. Do check HYDRAULIC OIL/water glycol mixture is Free of any contamination.
6. Do Flush the tank in every 2 months.
7. Do read the manual properly before testing.
8. Do follow the test schedule.
9. Do check the QCDC Connections properly before pressurizing the system.
10. Check the proper closing of the Valves in operation.
13. If any leakage is detected close the appropriate Valve.

# HYDRAULIC FLUSHING RIG

14. Ensure that all nuts, bolts, screws, clamps, pipe connections and Covers are properly tightened.





# HYDRAULIC FLUSHING RIG

15. Ensure that all filter elements are clean.



**Pressure line filter**



**Booster line filter**

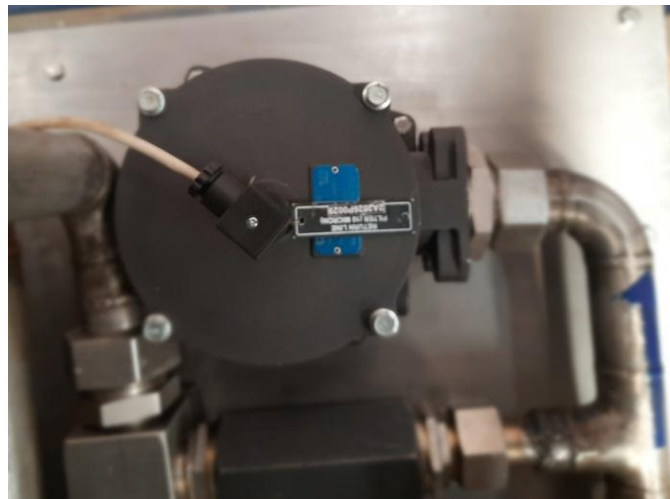

**Return line filter**

## 11. Don'ts

1. Do not operate flushing Rig. If you are not trained on the system.
2. Do not Run the system if supply/return line valve is closed.
3. Do not disturb any Items of System while system is running.
4. Do not use cotton waste for cleaning purpose (Use lint free cleaning cloth)
5. In case of any fault, do not run machine unless fault is rectified.
7. Do not attempt to run, when oil temperature is more than 60 °C.
8. Do not run the system if filter clogging indication comes on electrical panel.
9. Don't run the motor if the Oil Level is Low.
10. Don't run the motor if the Oil is contaminated.
11. Don't run the motor in anticlockwise direction.
12. Do not let Filler Breather open



# HYDRAULIC FLUSHING RIG

## 12. Safety Features & Safety Interlocking:

Safety equipment's are provided for normal operation.

### i) Visual Indication & Switches

a) Oil Level Gauge.



b) Filter Clogging Indicator.





# HYDRAULIC FLUSHING RIG

## c) Low Oil Level switch Indicator.



## d) Temperature Indicator



Temperature transmitter

# HYDRAULIC FLUSHING RIG

e) Emergency stop push button.



f) Temperature gauge





# HYDRAULIC FLUSHING RIG

## ii) Interlocks:

a) Emergency button push to lock position.



b) Control Circuit MCB trip.

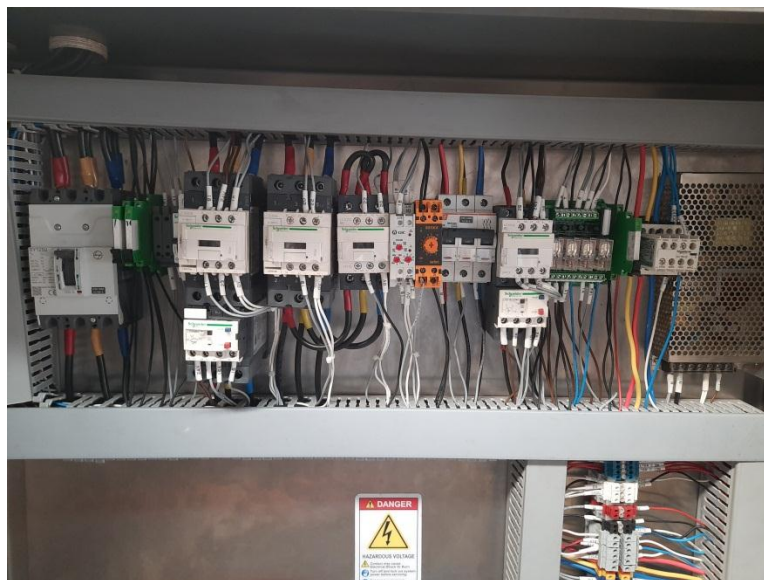

# HYDRAULIC FLUSHING RIG

## 13. Service & Maintenance Instructions

FREQUENCY		(service and maintenance actions)
<b>Before / after each use</b>	△	Check 3phase supply. Perform the visual check of the complete System.
	△	During Operation observe leakage, if any.
	△	Release Pressure from All Pressure Gauges/Pressure Transmitters on the Panel. Each gauge/Digital Indicator on the Panel should READ ZERO Pressure after completion Of operation.
	△	Check for the Leakage of the tubing/Piping And fittings, if any. Clean the complete System to ensure Dust & Dirt Free system.
<b>Every Month</b>	△	Check the Pump for external leakage & Overall performance.
	△	Clean the Filter and Filter Elements
	△	Check for loosening of Nuts and bolts or pipe Adaptors. Re-torque if needed
	△	Inspect piping at full system pressure for Leakage using pressure drop.
	△	Test & calibrate all pressure Gauges/ Sensors / Transmitters. Check All Wire condition.
	△	Check All filter ELEMENTS.
	△	Get Valve, Pressure Relief Valve in the Checked for performance.
<b>Every 3 months\</b>	△	Change the all major Items :Flow Meter, Relief Valve, Pressure control valve, Motor, power supply , Pump etc.
<b>Every 6-12 Months</b>		
<b>Every 5 Years</b>		

## **Weekly Maintenance:**

Nut bolt tightness of system, pipe flanges bolts, pipe adaptors, and pipe Connectors, tube fittings looseness any nut bolts are pipe related which Are exposed to vibrations.

## **Monthly Maintenance:**

Any soft sealing in pipe line check, manifolds seating area check for Every month, change oil every 6 week, calibration certificate of Instruments and Gauges fold the hose and check crack line etc.

## **Yearly Maintenance:**

Calibration of Instruments and Gauges, any Wear and tear due to vibration in system, fold the hose and check both supply and return Line etc.

# HYDRAULIC FLUSHING RIG

## (14) TROUBLE SHOOT CHART:

S.N	Problems	solution
1.	If there is any leakage at fitting during run the machine	For heavy leakage use emergency switch so that it completely shut down the whole system then tighten the fitting by using proper tools and for drop wise leakage first release the pressure by fully opening needle valve then unloading, then use stop Button of main pump motor then use <b>emergency button</b> , then tighten the fitting by using proper tools.
2.	Vibration of main pump	Tighten the base bolts of main pump motor and tighten the bolt connecting between bell housing and main pump motor and between bell housing and main pump.
3.	If cooling performance of air cooler isn't good and fins of air cooler is dirt and its pours is closed.	Use <b>air</b> for removing dirt of fins and opening the pours of fins so that it sucks air freely and give better cooling performance.
4.	IF flow meter doesn't showing the correct reading as mention in performance chart	Open pump supply line and check flow is coming or not. If flow is coming, check sensor mounted on flow meter and also check wiring is proper.
5.	If sound is coming more from the motor	Check current, if more than rated, check alignment between motor and pump.
6.	If oil temperature reached the maximum limit i.e. 60 degree centigrade and machine doesn't automatically stop and temperature still increasing.	Use <b>emergency button</b> directly for stop the machine and if it doesn't work then cut off the power from main supply. After sometimes supply the power and then . Check if cooling line pump motor is in running. .check if flow is coming out from outlet of air cooler.
7.	When pump is running but pressure is not coming on pressure gauge.	Open return pressure line QCDC and see flow is coming or not. If sufficient flow is coming then check relief valve adjustment knob.

## 15. Tools Supplied

- Allen SET  
Contain: 1 TO 10 MM, 14MM
  
- Spanner set  
Contain: (one set each)
  - 10-11mm
  - 12-13mm
  - 14-15mm
  - 16-17mm
  - 18-19mm
  - 20-22mm
  - 21-23mm
  - 24-27mm
  - 30-32mm
  - 41-36mm
  - 38mm
  - 50mm
  - 55mm
  - 60mm
  - 80 mm

## 16. Drawings & Major Catalogues

- GA DRAWING
- HYDRAULIC CIRCUIT
- ELECTRICAL CIRCUIT DIAGRAM